

STEP 1

****See Mounting Template on Reverse for Further Instructions****

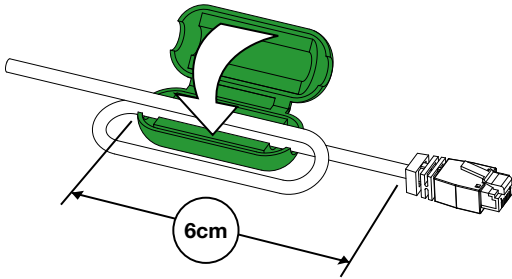

STEP 2

A squeeze
B pull

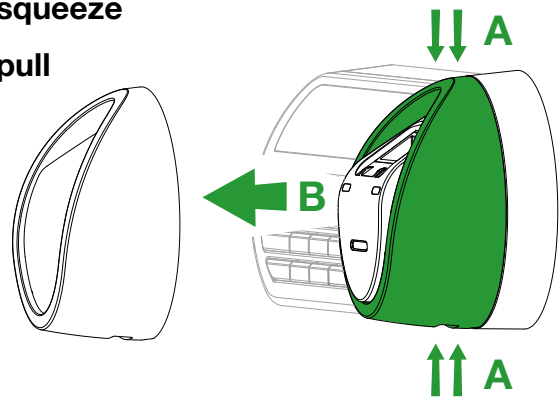

STEP 3

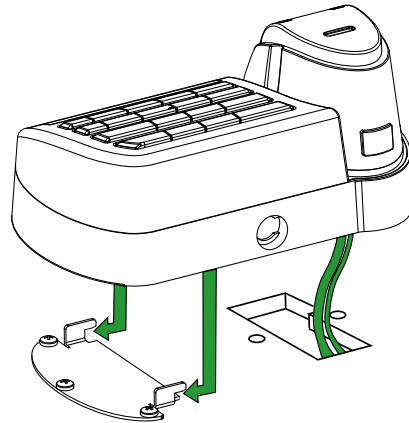
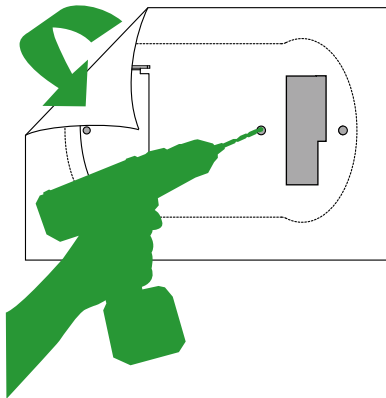

STEP 4

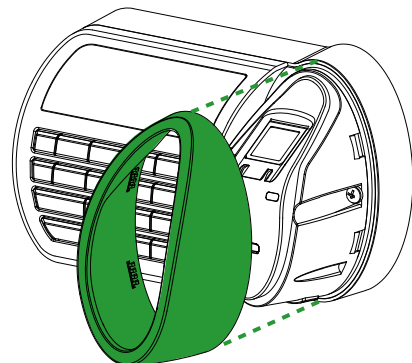
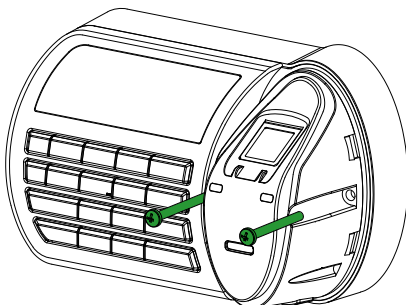
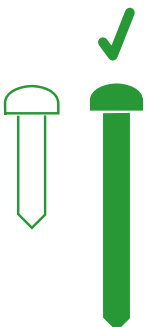

STEP 5

Please Note:

- ✓ Allow 50cm clearance on all sides of the device
- ✓ Ensure vertical space beneath the mounted device and the floor is clear
- ✓ Do Not mount under Air Conditioners
- ✓ Do Not mount near doors that will cause obstruction when open
- ✓ Do Not mount where a person using the device will cause obstructions to passage of people or goods

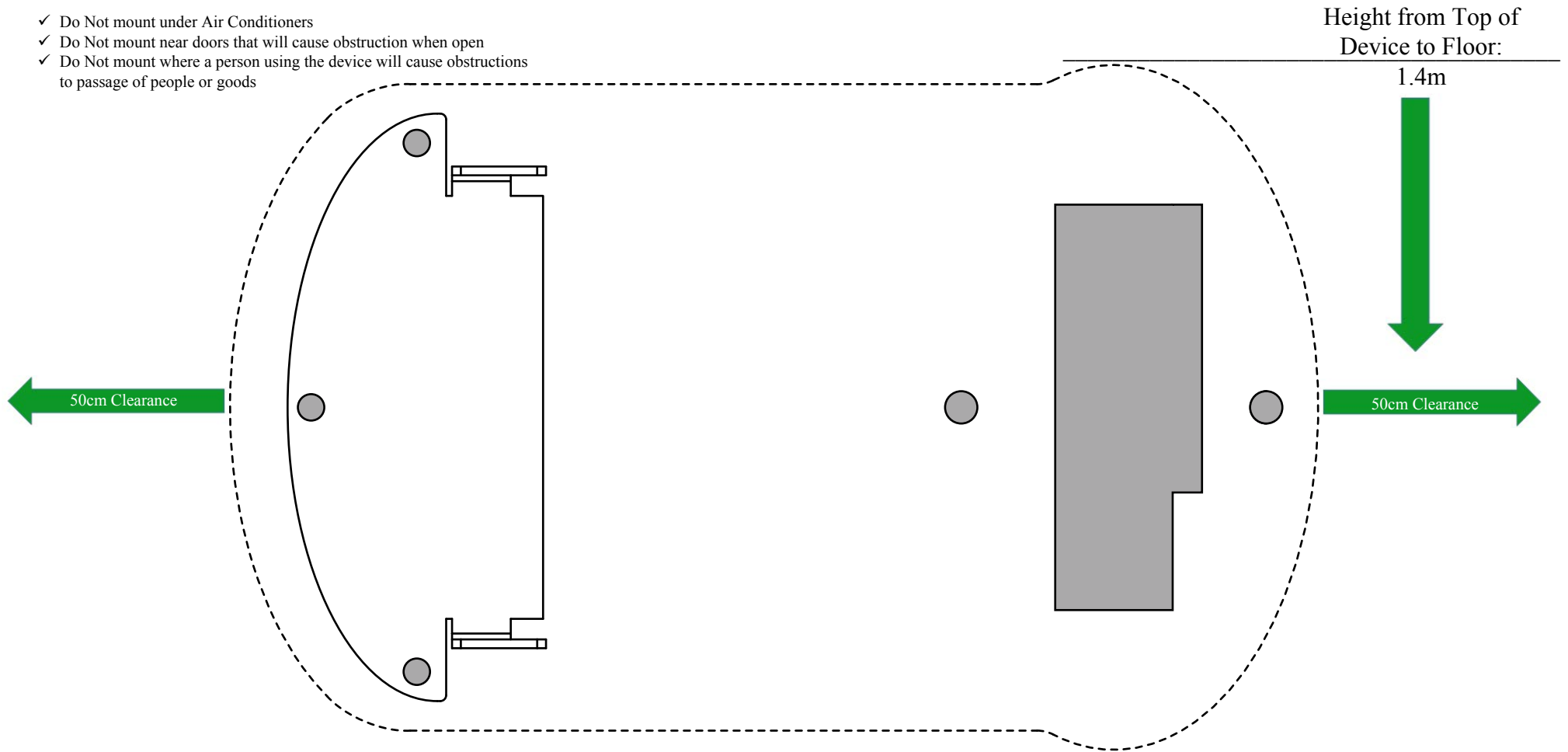

Your assistance is greatly appreciated. Please do not hesitate to call PeopleKey Support if you wish to discuss any aspect of the physical installation of the device

www.peoplekey.com
Local phone: 1800 015 458
International phone: +61299607200

DRILLING TEMPLATE
SCALE 1 : 1